

NOTICE DE MONTAGE  
 ASSEMBLY INSTRUCTIONS  
 MONTAGEANLEITUNG  
 ISTRUZIONI DI MONTAGGIO  
 INSTRUÇÕES DE MONTAGEM  
 INSTRUCCIONES DE MONTAJE  
 UPUTE ZA MONTAZU  
 MONTAJ TALIMATI

15343 - 15361

MUEBLE TV 2P2H SERIGRAFIA  
 MEUBLE TV 2P2N SERIGRAPHIE  
 TV CABINET 2D2H SERIGRAPHY

ME  
 marckeric

MARCKERIC S.L.  
 C / ENLACE VEROLA S/N,  
 PC: 46430/SOLLANA / VALENCIA / SPAIN

EAN CODE

8435178390868  
 8435178391025

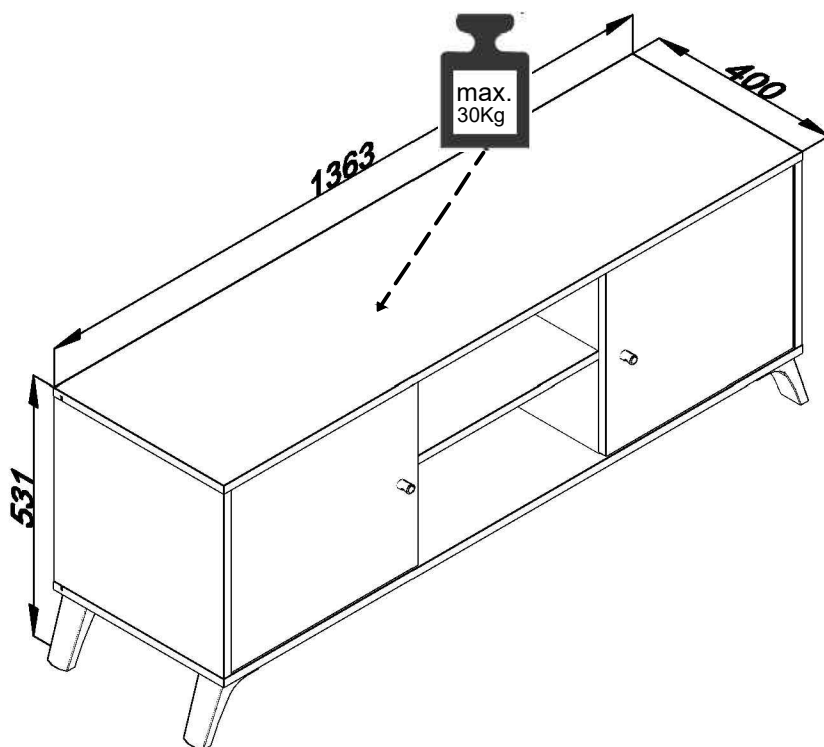

À MONTER SOI-MÊME

AVANT DE COMMENCER, SE  
 REPORTER AUX CONSEILS  
 DE MONTAGE EN ANNEXE  
 BEFORE STARTING, REFER  
 TO THE ASSEMBLING ADVICE  
 IN ANNEX  
 VOR DER MONTAGE,  
 BEILIEGENDE ANWEISUNGEN  
 BEFOLGEN.  
 PRIMA DI COMINCIARE  
 LEGGETE LE ISTRUZIONI DI  
 MONTAGGIO  
 ANTES DE COMERÇAR, ADIAR  
 SE AOS CONSELHOS DE  
 MONTAGEM EM ANEXO  
 ANTES DE EMPEZAR  
 CONSULTE LOS CONSEJOS  
 PARA EL MONTAJE  
 PRIJE POČETKA MONTAŽE  
 MOLIMO PAŽLJIVO  
 PROČITAJTE UPUTE ZA  
 MONTAŽU  
 BASLAMADAN ÖNCE,  
 EKTEKI MONTAJ TALIMATLARINI  
 İNCELEYİNİZ

Caja Colis	Tamaño de la caja Dimensions colis	Peso bruto Poids brut	Peso neto Poids net
1/1	1597 x 413 x 94	26,4 Kg	25,8 Kg

"IMPORTANT- À CONSERVER POUR RÉFERENCE ULTÉRIEURE-LIRE ATTENTIVEMENT"

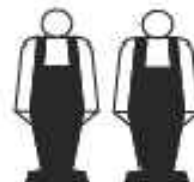
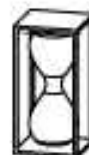

1h:10 min

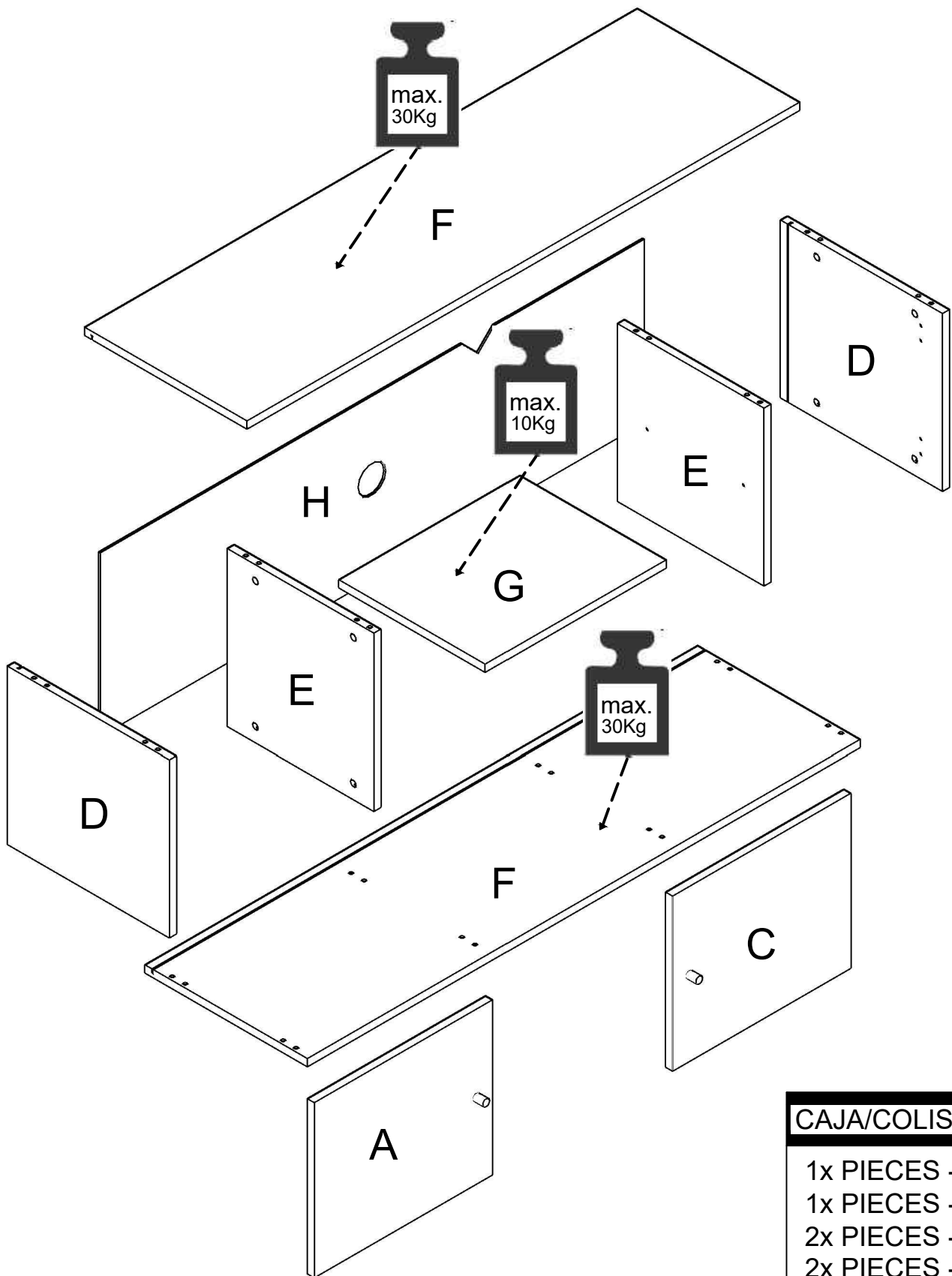

**CAJA/COLIS 1/1**

- 1x PIECES - A
- 1x PIECES - C
- 2x PIECES - D
- 2x PIECES - E
- 2x PIECES - F
- 1x PIECES - G
- 1x PIECES - H



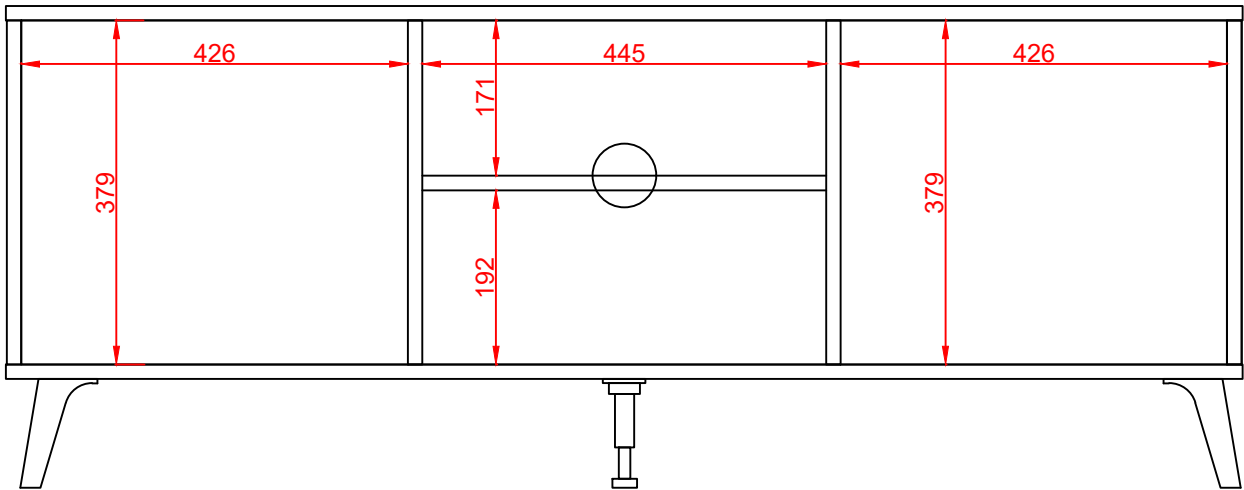



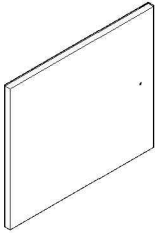
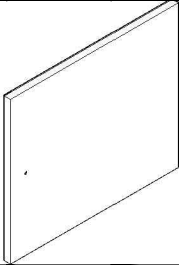
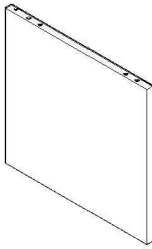
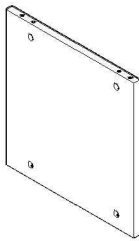
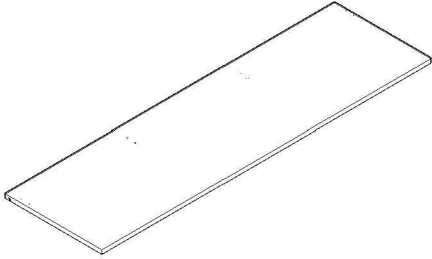
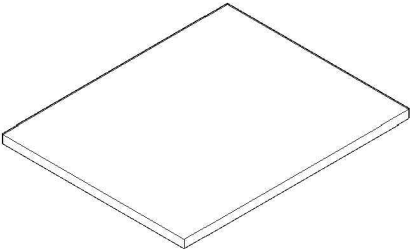
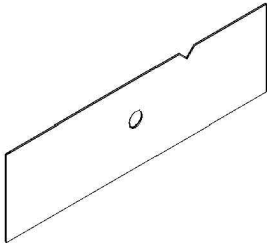



QUINCALLERIE  
 NOTICE DE  
 MONTAGE



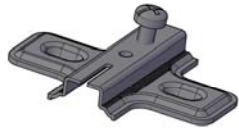
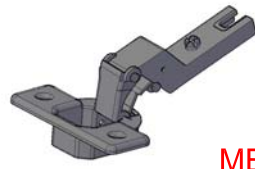

## LISTADO DE PIEZAS - COMPOSANTS - PARTS LIST

<p><b>A</b></p> 	
<p>5AT1FXXX 1 Pc 439 x 373 x 16</p>	
<p><b>C</b></p> 	<p><b>D</b></p> 
<p>5AT1FXXX 1 Pc 439 x 373 x 16</p>	<p>1LA9870 2 Pc 379 x 399 x 16</p>
<p><b>E</b></p> 	<p><b>F</b></p> 
<p>1LA9871 2 Pc 379 x 361 x 16</p>	<p>1EN9067 2 Pc 1363 x 400 x 16</p>
<p><b>G</b></p> 	<p><b>H</b></p> 
<p>1SI9744 1 Pc 445 x 360 x 16</p>	<p>MTB2168 1 Pc 1341 x 391 x 3</p>

# HERRAJES - QUINCALLERIE - HARDWARE

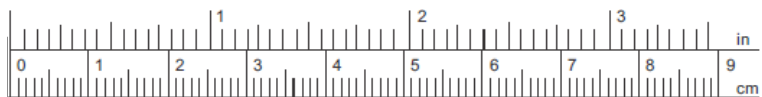

<p>② x16</p>  <p>MTR0420 3,5x15</p>	<p>⑧ x16</p>  <p>MTR0715</p>	<p>⑮ x16</p>  <p>MTR0720</p>
<p>⑮ x16</p>  <p>8x30 MVA0090</p>	<p>⑳ x4</p>  <p>MBB0403</p>	<p>㉔ x4</p>  <p>MBB0273</p>
<p>㉔ x4</p>  <p>MTR0630</p>	<p>㉔ x2</p>  <p>MPM0855</p>	<p>㉔ x1</p>  <p>MCL0090</p>
<p>⑨① x6</p>  <p>MVA0971</p>	<p>⑨② x1</p>  <p>MVA2387</p>	<p>⑨③ x4</p>  <p>MVA2252</p>
<p>⑨④ x1</p>  <p>MPP0005</p>		



<p>②</p>		<p>3,5x15</p>
<p>⑮</p>		<p>8x30</p>

**1**

"UTILISATION D'UNE COUVERTURE RECOMMANDÉE  
AFIN DE NE PAS ABIMER LES PIÈCES LORS DU MONTAGE"

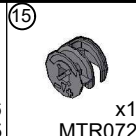
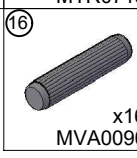
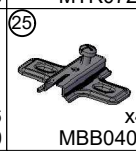
- |   |   |   |
|---|---|---|
| <br>x8<br>MTR0420  | <br>x16<br>MTR0715 | <br>x16<br>MTR0720 |
| <br>x16<br>MVA0090 | <br>x4<br>MBB0403  |   |

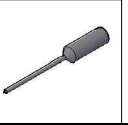
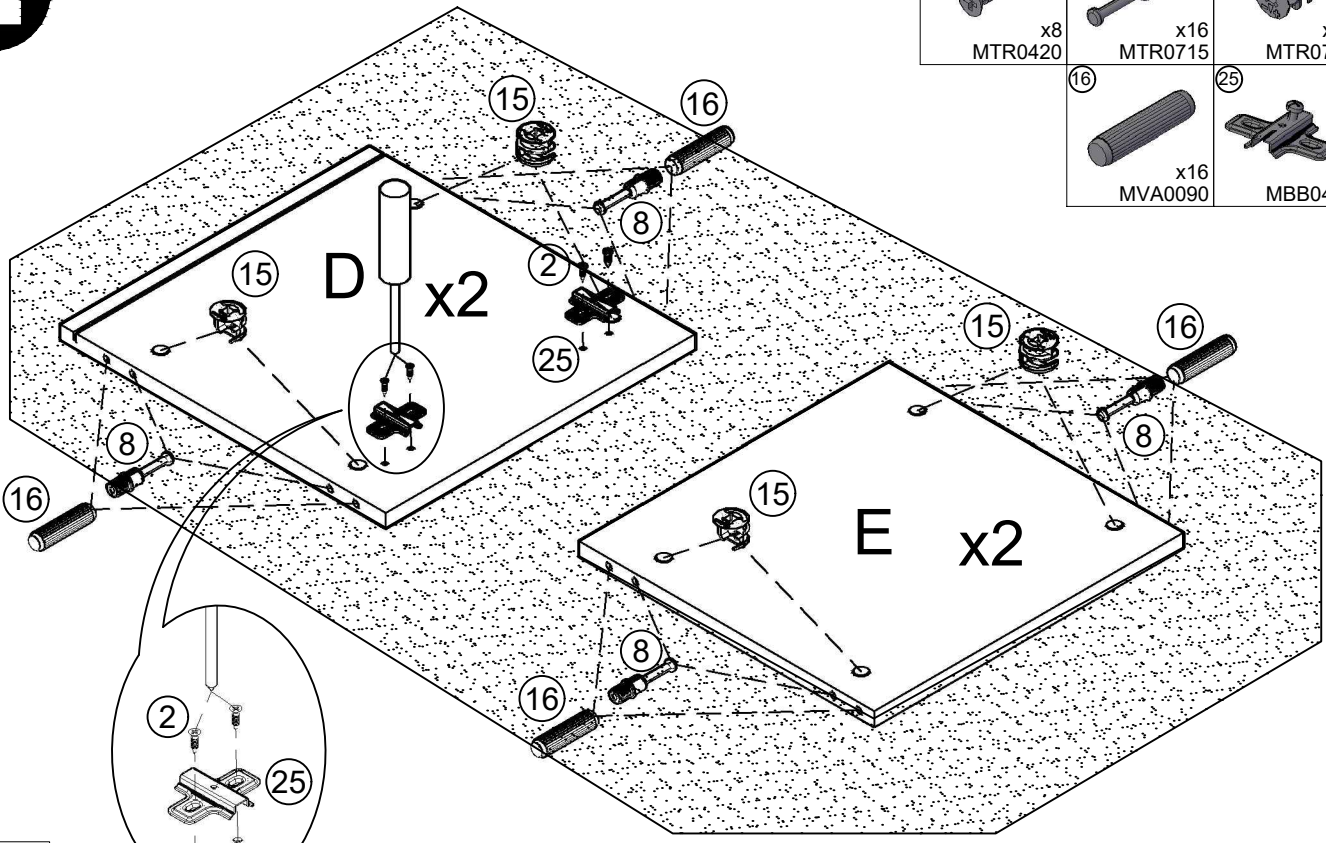

**2**

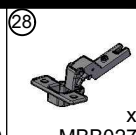
- |  |  |
|--|--|
| <br>x8<br>MTR0420 | <br>x4<br>MBB0273 |
|--|--|

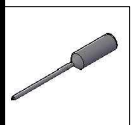
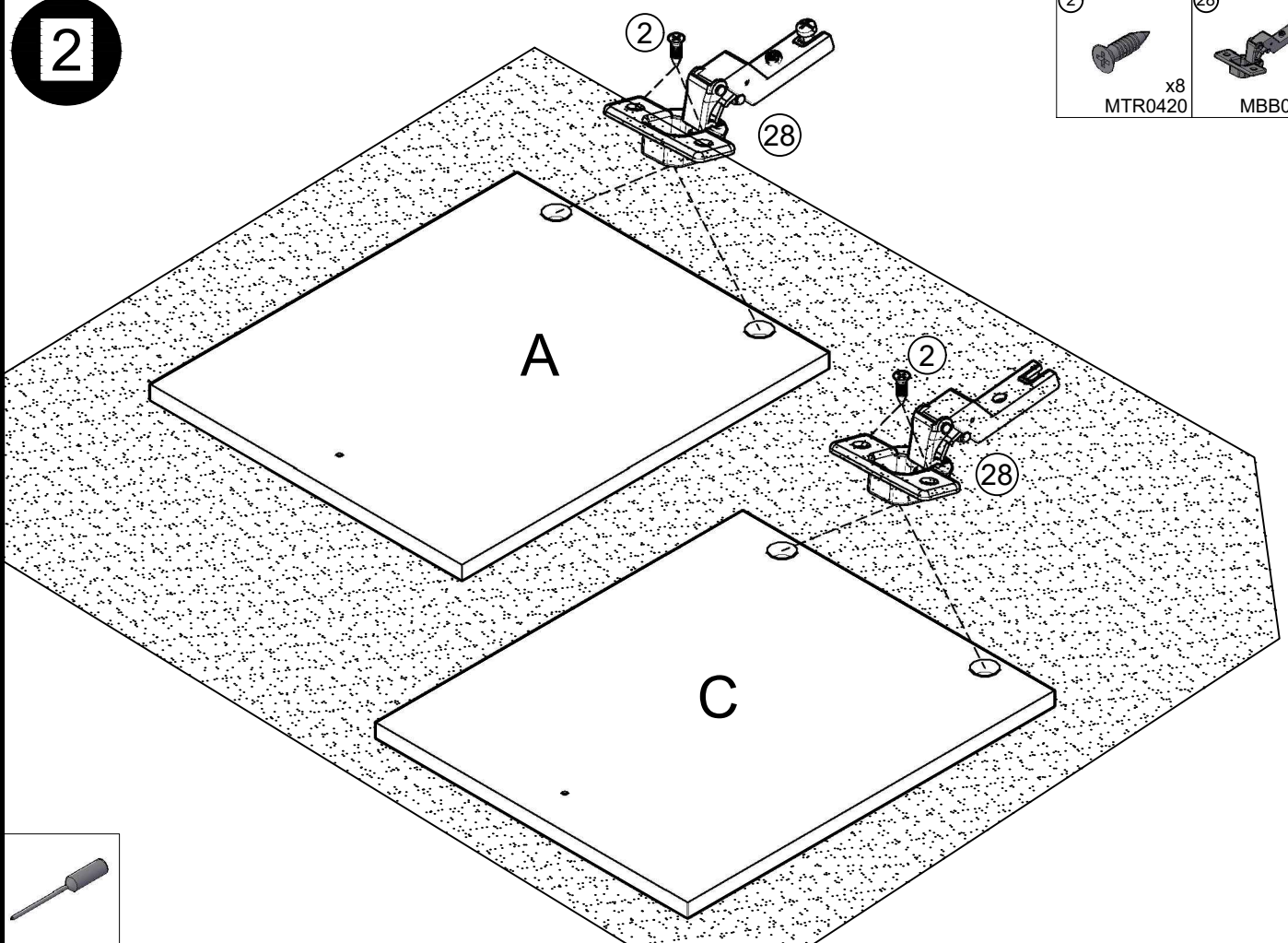

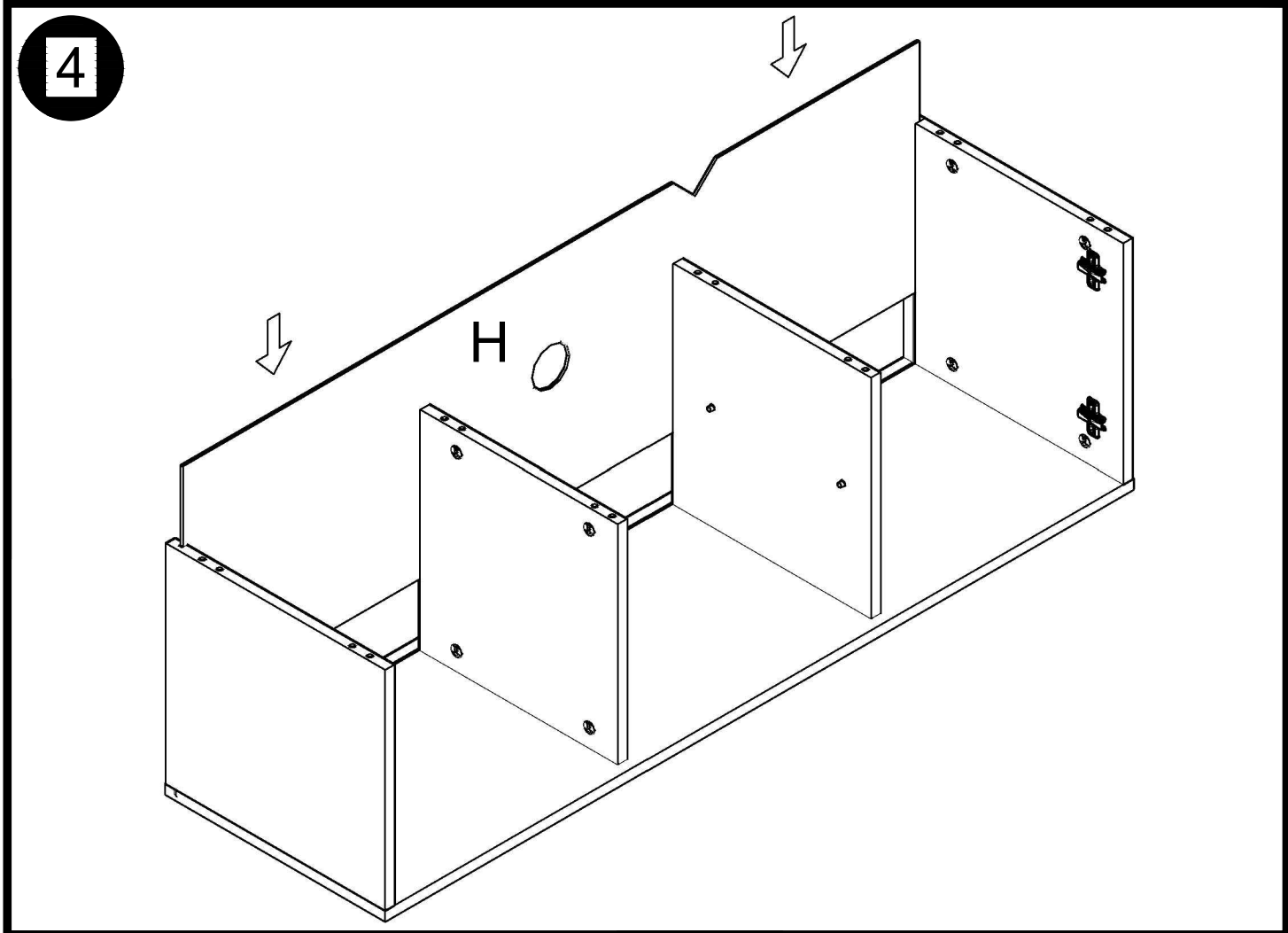
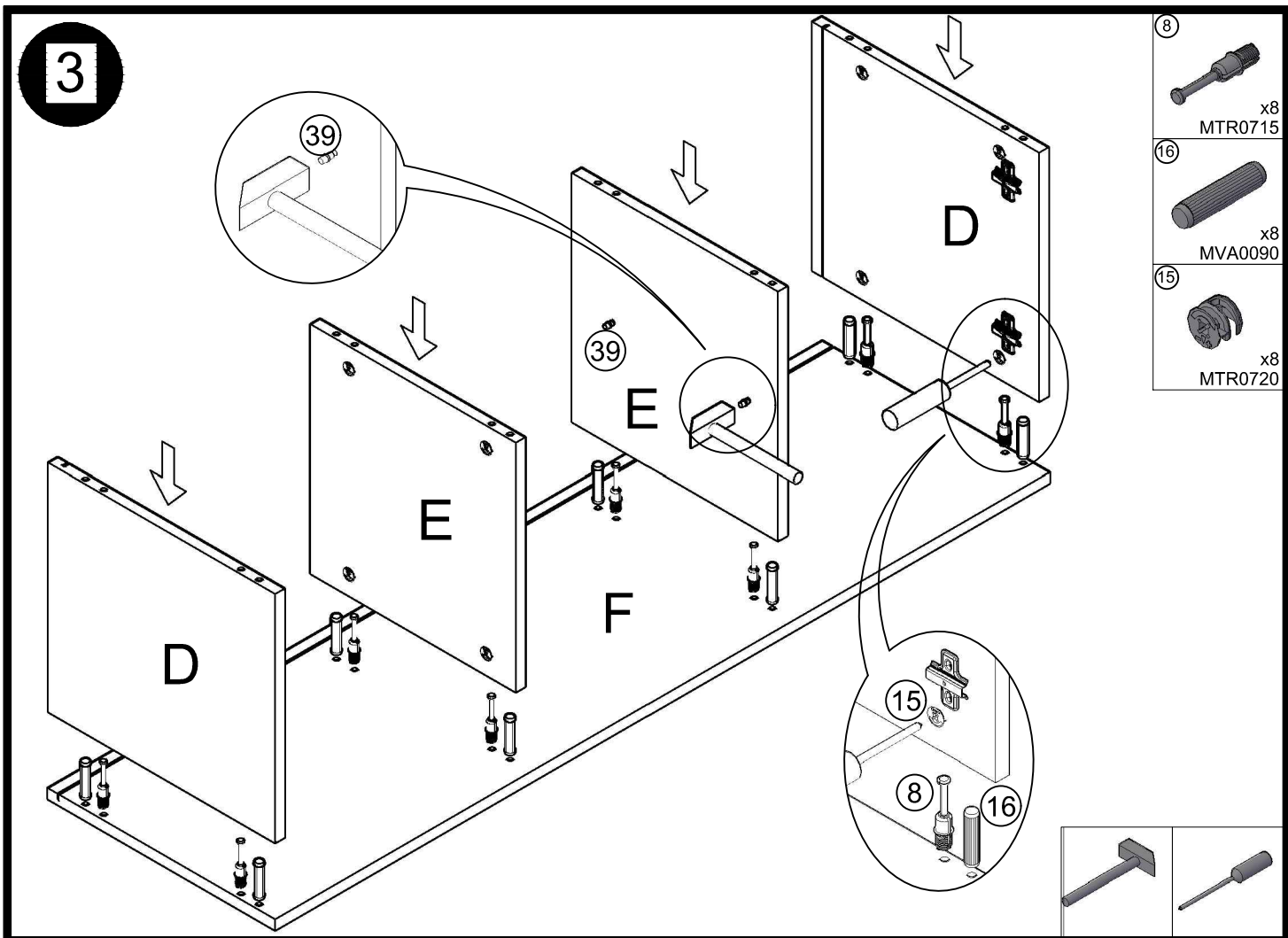

5

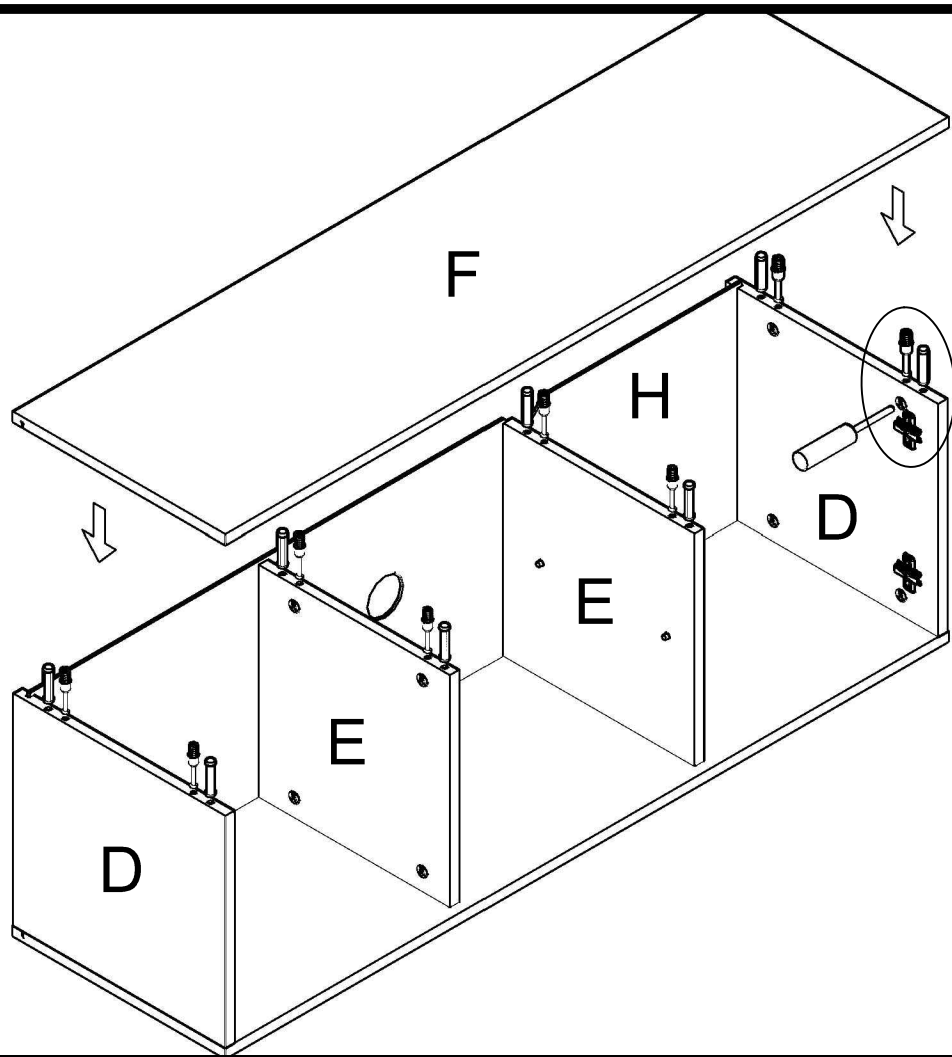

- 8 x8 MTR0715
- 16 x8 MVA0090
- 15 x8 MTR0720

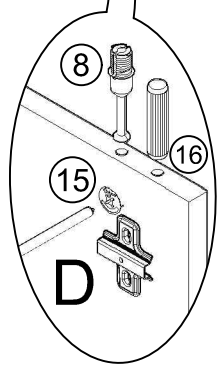

6

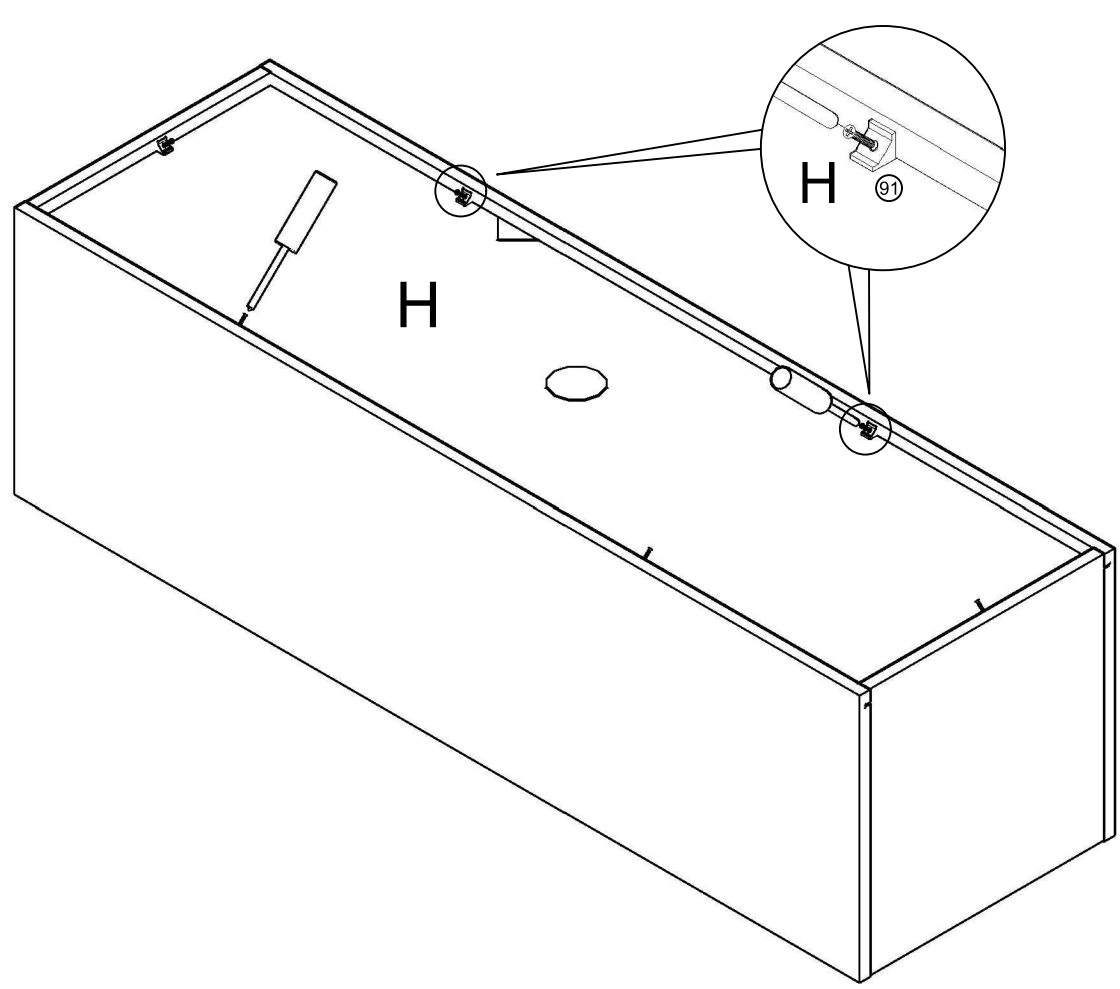

- 91 x6 MVA0971

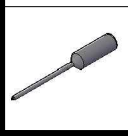

7

93  
x4  
MVA2252

94  
x1  
MPP0005

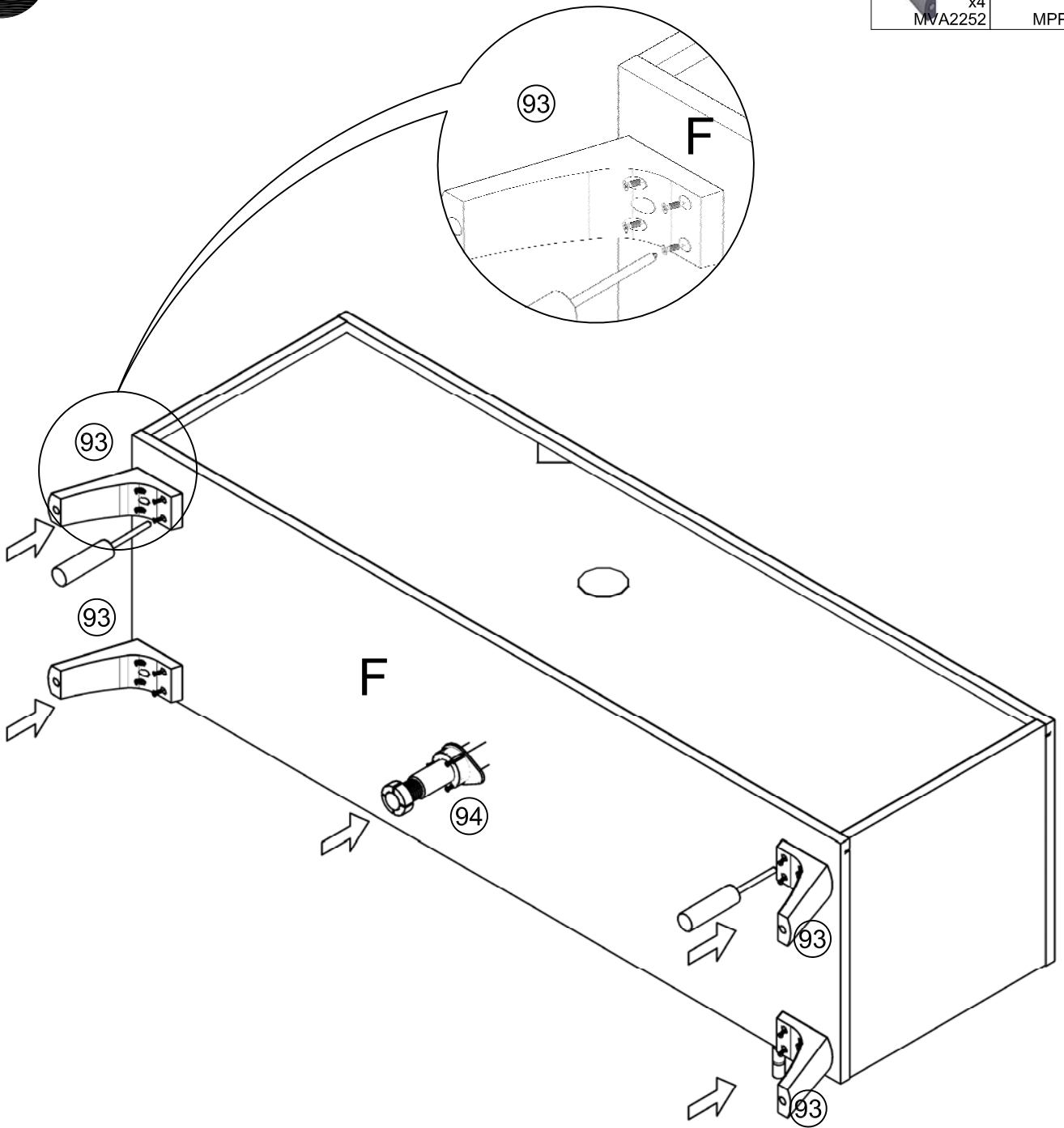





## FIXATION MURALE OBLIGATORIE

UTILISEZ DES VIS ET DES CHEVILLES ADAPTÉES A VOS MURS



Il existe une grande diversité de types de murs ou cloisons, c'est la raison pour laquelle nous ne pouvons vous fournir une quincaillerie adaptée à votre mur. Il est nécessaire d'identifier le type de paroi à laquelle vous allez fixer ce produit afin de vous procurer les fixations appropriées. En cas de besoin, adressez vous à un magasin spécialisé pour conseil



## OBLIGATORIO FIJAR A LA PARED

UTILICE LOS TORNILLOS Y TACOS ADECUADOS PARA SU MURO



Existe una gran diversidad de muros y paredes, por esta razón no podemos proporcionarle el herraje adecuado para su pared. Primero, es necesario identificar el tipo de pared para luego utilizar el herraje adecuado. En caso de duda, diríjase a una tienda especializada para más información.



## OBLIGATORY FIX ON THE WALL

USE SCREWS AND PLUGS SUITABLES FOR YOUR WALL



Due to the wide diversity of wall or partition types, we cannot provide you with suitable attachment fixtures. To determine which attachment fixtures to use, you will need to identify the type of wall to which you will be fixing this product. If you have whatever doubt, please, go to one specialised shop for further information.

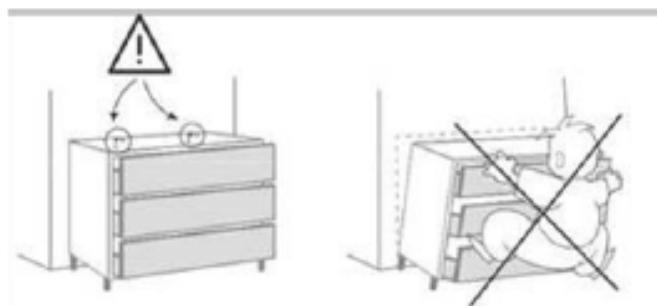

French

**IMPORTANT:** Pour éviter le basculement accidentel du meuble, la fixation du meuble au mur est obligatoire.

La visserie nécessaire pour la jonction mur/meuble, dépendante de la nature du mur, n'est pas fournie. En cas de doute, consulter un spécialiste

English

**IMPORTANT:** To avoid the accidental tip-over of the furniture, the fixing of the furniture on the wall is mandatory.

The needed hardware for the junction wall/furniture, depending of the nature of the wall, is not provided. If any doubt, consult a specialist.

Spanish

**IMPORTANTE:** Para evitar el vuelco accidental de los muebles, es obligatorio fijarlos en la pared.

El tipo de tornillos necesarios para fijar el mueble a la pared, dependen del material de la pared, no se suministran. En caso de duda, consulte a un especialista



Esiste una gran varietà di tipi di muri o paratie e noi siamo in grado di fornirvi il tipo esatto di fissaggio per ognuno di essi. E' necessario identificare il tipo di parete alla quale intendete fissare questo prodotto in modo da fornirvi i fissaggi più idonei, Ecco qualche esempio di fissaggi consigliati per :

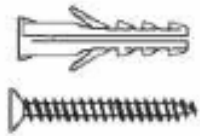
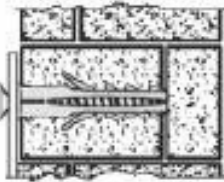
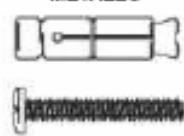
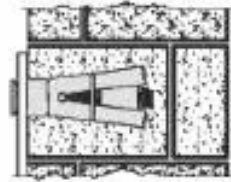
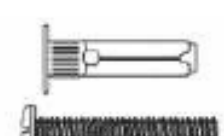
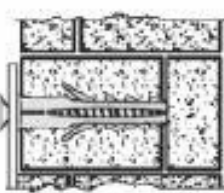
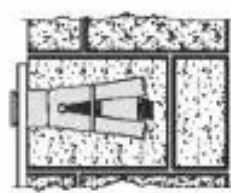
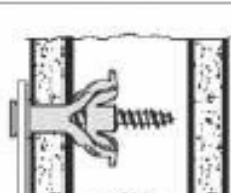
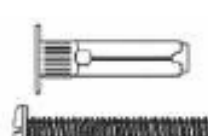
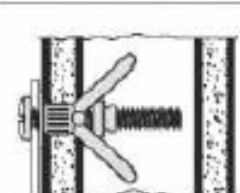

I MURI PIENI		PARATIE CAVE		
<b>TASSELLO NYLON "FISCHER"</b>  	<b>TASSELLO DI ANCORAGGIO IN METALLO</b>  	<b>TASSELLO DI ANCORAGGIO AD ALETTE IN NYLON</b>  	<b>TASSELLO METALLICO AD ESPANSIONE</b>  	<b>TASSELLO "MOLLY"</b>  









Utilizzare una punta di trapano adatta agli utensili utilizzati e al tipo di muro.

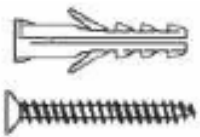
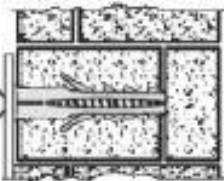

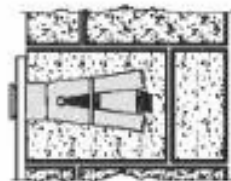
Il existe une grande diversité de types de murs ou cloisons, c'est la raison pour laquelle nous ne pouvons vous fournir le type exact de fixation. Il est nécessaire d'identifier le type de paroi à laquelle vous allez fixer ce produit afin de vous procurer les fixations appropriées. Voici quelques exemples de fixations conseillées pour :

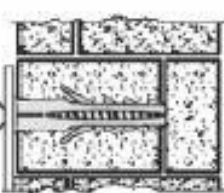
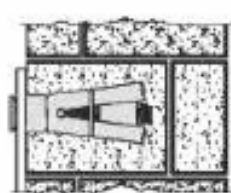
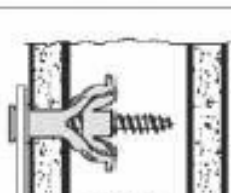

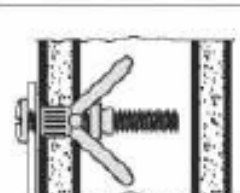
LES MURS PLEIS		LES CLOISONS CREUSES		
<b>Cheville nylon "FISCHER"</b>  	<b>Cheville d'ancrage métal</b>  	<b>Cheville d'ancrage A ailettes en nylon</b>  	<b>Cheville métallique A expansion</b>  	<b>Cheville "MOLLY"</b>  



Utiliser une talle de forêt adaptée à la quincaillerie utilisée et au type de mur.

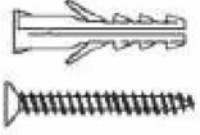
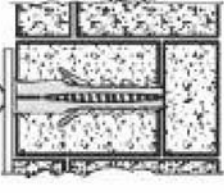
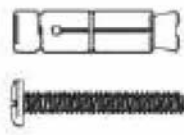
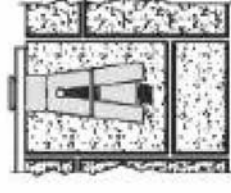
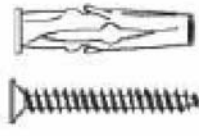
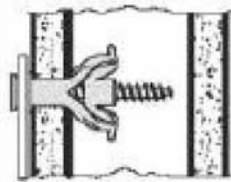
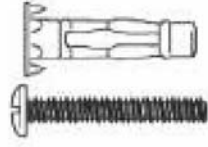
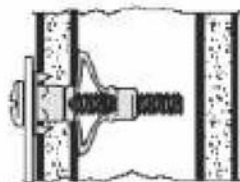
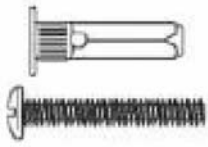
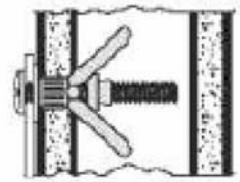

Due to the wide diversity of wall or partition types, we cannot provide you with suitable attachment fixtures. To determine which attachment fixtures to use, you will need to identify the type of wall to which you will be fixing this product. Here are some examples of attachment fixtures recommended for:

BLIND WALLS		STUDDED WALLS		
<p><b>"FISCHER" Nylon plug</b></p>  	<p><b>Metal Wall plug</b></p>  	<p><b>Nylon winged Wall plug</b></p>  	<p><b>Metal expansion plug</b></p>  	<p><b>"MOLLY" plug</b></p>  



Use a drill bit that is compatible in size with the hardware used and the type of wall.

**8**

**FIXATION MURALE OBLIGATORIE**  
**OBLIGATORIO FIJAR A LA PARED**  
**OBLIGATORY FIX ON THE WALL**

92 x1  
MVA2387

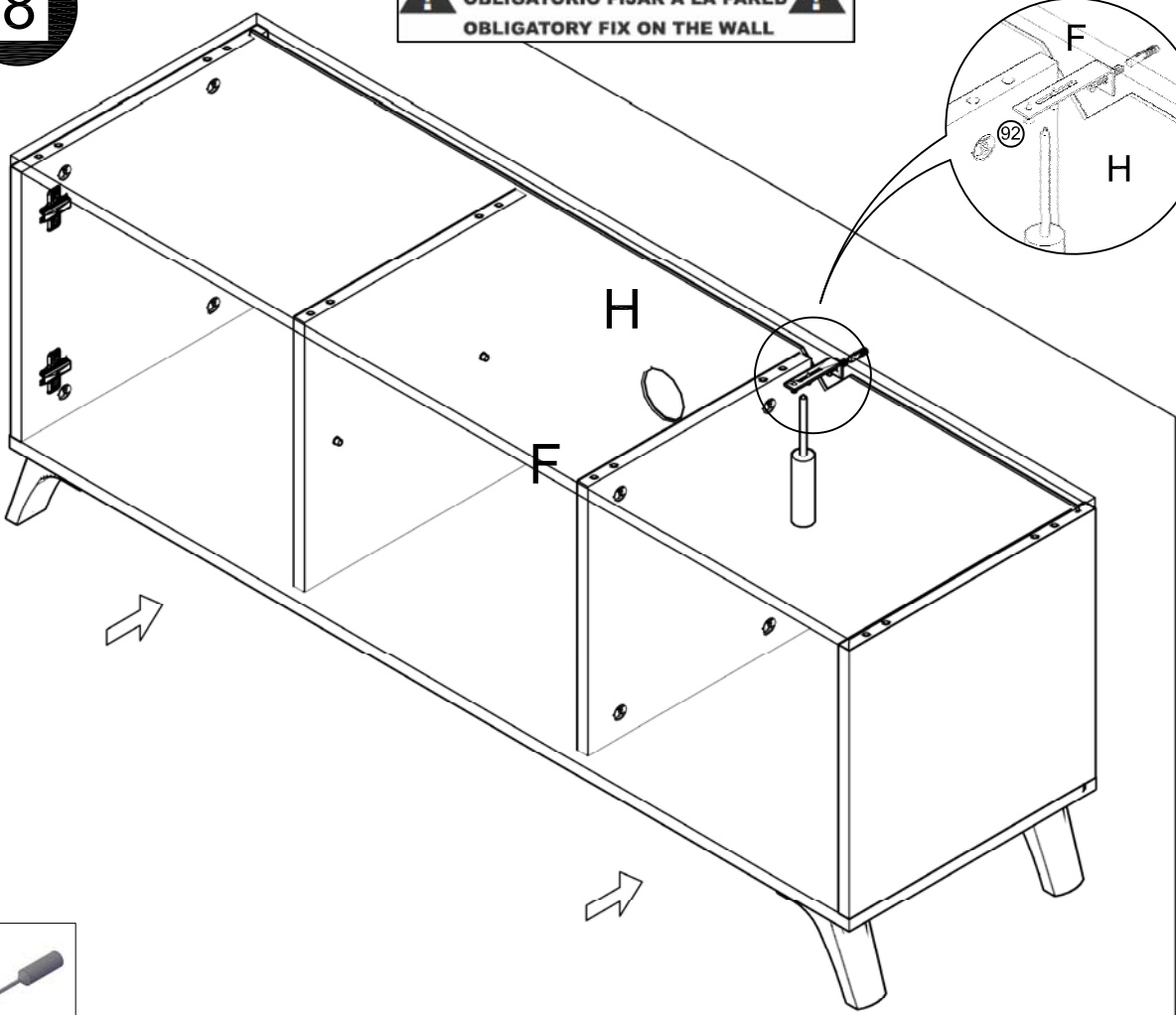

9

- (25) x4 MBB0403
- (28) x4 MBB0273
- (40) x2 MPM0855

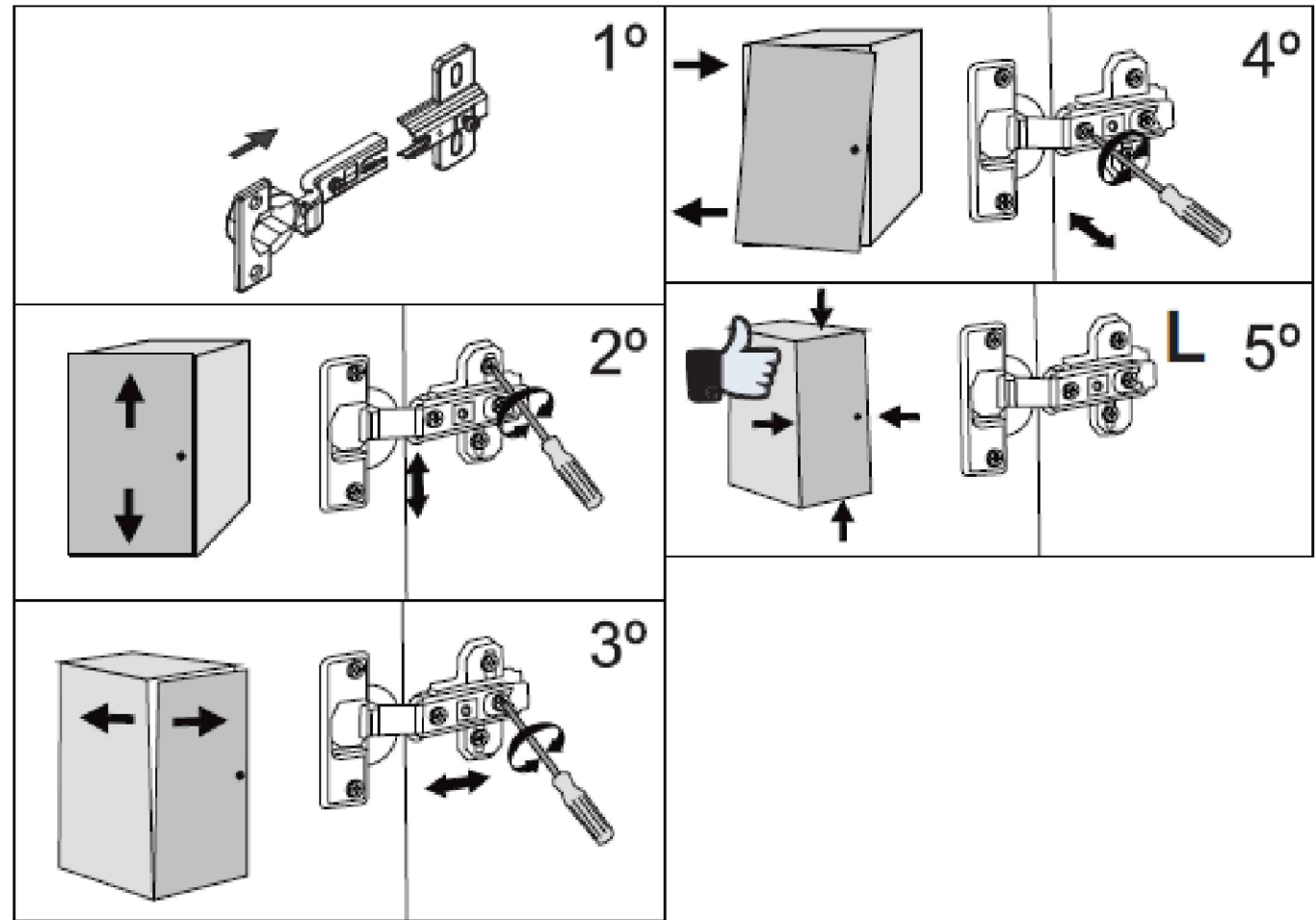
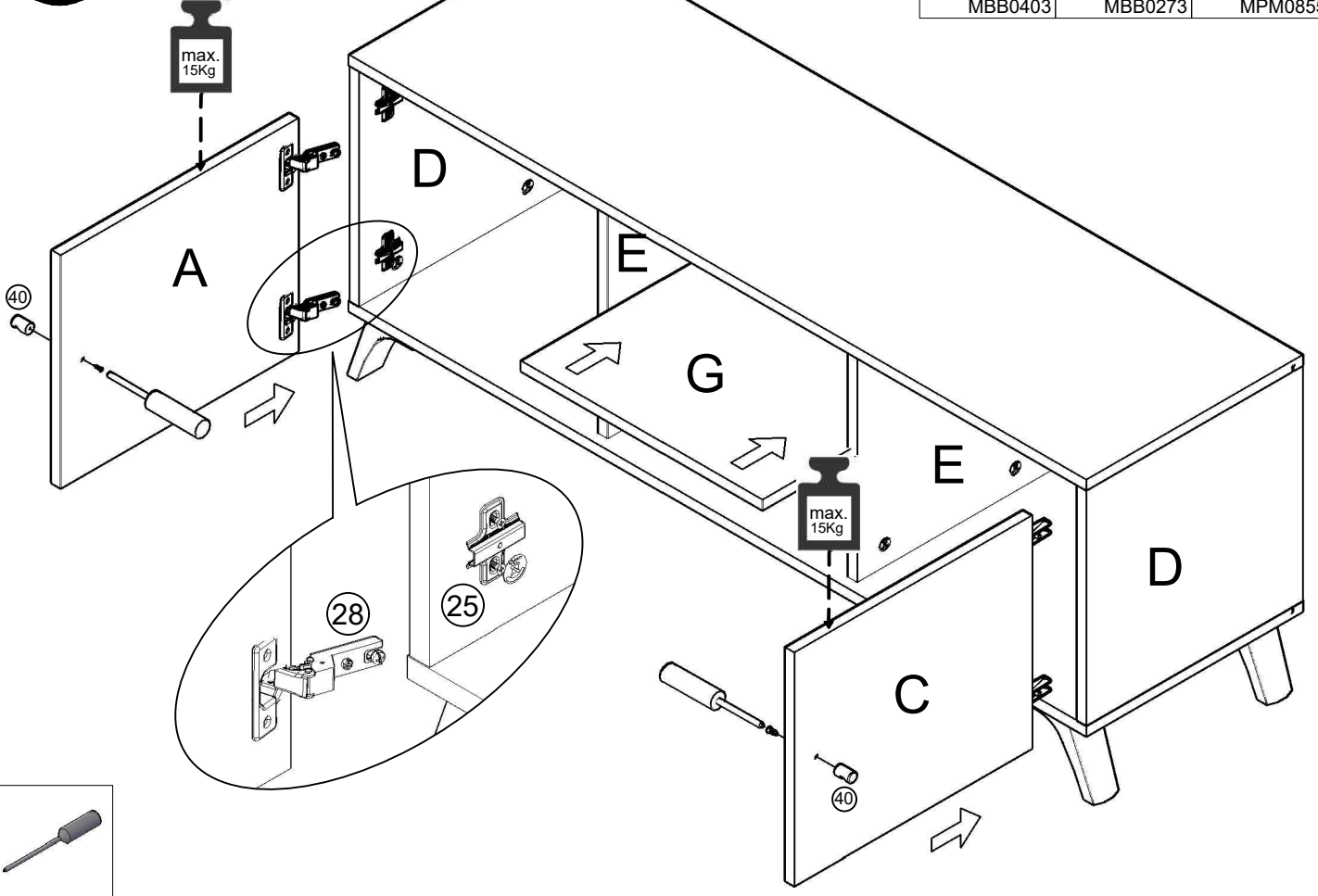

**FRENCH:** "Les meubles contenant des panneaux à base de bois (panneaux de particules, panneaux de fibres, contreplaqué...) peuvent émettre des substances polluantes dans l'air intérieur. Il est ainsi recommandé, après l'installation du meuble dans son logement, d'aérer fréquemment la pièce concernée pendant au moins quatre semaines afin de réduire son exposition aux polluants émis par le meuble."

**SPANISH:** Los muebles que contienen paneles a base de madera (Aglomerado, cartón, contrachapado ...) pueden emitir sustancias contaminantes en el aire. Por lo tanto, se recomienda airear frecuentemente los muebles al menos durante cuatro semanas después de su instalación para reducir su exposición a los contaminantes emitidos por los muebles.

**ENGLISH:** Furniture containing wood-based panels (Particle board, fibreboard, plywood ...) could emit pollutants on the air. Therefore, it is advisable to ventilate the furniture at least during four weeks after its assembly in order to reduce the exposure to the pollutants released by the furniture.

## FRANCAIS - SUISSE

### CONSEILS DE MONTAGE :

- 1 > BIEN ETUDIER LA NOTICE DE MONTAGE.
- 2 > REPEREZ LES PIÈCES CONSTITUANT VOTRE MEUBLE.
- 3 > REGROUPEZ ET CONTROLEZ LA QUINCAILLERIE.
- 4 > MUNISSEZ-VOUS DE L'OUTILLAGE NECESSAIRE.
- 5 > AMENAGEZ-VOUS UNE ZONE DE MONTAGE.
- 6 > PROCEDEZ AU MONTAGE.



**NE JAMAIS FORCER LES ASSEMBLAGES.  
RESSERREZ LES VIS APRES QUELQUES TEMPS D'USAGE.  
GARDER VOTRE NOTICE DE MONTAGE, SI UNE PIÈCE  
VENAIT A MANQUER, ELLE SERAIT LE PLUS CLAIR  
MOYEN DE COMMUNIQUER AVEC VOTRE MAGASIN.**

### CONSEILS D'ENTRETIEN :

- 1 > DÉPOUSSIÉREZ SOIGNEUSEMENT.
- 2 > UTILISEZ UN CHIFFON SEC.



**- NE JAMAIS UTILISER  
DE PRODUITS ABRASIFS:  
POUDRE, LAINE D'ACIER, SOLVANTS.  
- NE PAS MOUILLER**

	PAPIER DECOR	SURFACES STRATIFIÉES	SURFACES LAQUÉES	BOIS VERNIS	TEXTILE CUIR
EAU SAVONNEUSE (SAVON NEUTRE)	○	○	○	○	○
EAU ADDITIO NÉE		○	○		
ENTRETIEN SPÉCIFIQUE FABRICANT					○

## DEUTSCH - SCHWEIZ

### MONTAGE ANLEITUNG:

- 1 > DIE MONTAGEANLEITUNG SORGFÄLTIG DURCHLESEN.
- 2 > DIE EINZELTEILE DES MÖBELSTÜCKS ERMITTELN.
- 3 > DIE BESCHLÄGE ZUSAMMENLEGEN UND PRÜFEN.
- 4 > DAS NOTWENDIGE WERKZEUG ZURECHTLEGEN.
- 5 > EINEN MONTAGEBEREICH FREIMACHEN.
- 6 > DAS MÖBELSTÜCK ZUSAMMENBAUEN.



**NIEMALS DIE VERBINDUNGEN ZU STARK ANZIEHEN.  
DIE SCHRAUBEN NACH EINIGER ZEIT DES GEBRAUCHS  
ERNEUT FESTZIEHEN. DIE MONTAGEANLEITUNG  
GUT AUFBEWAHREN: SOLLTE EIN TEIL FEHLEN, IST SIE DAS  
BESTE VERSTÄNDIGUNGSMITTEL MIT IHREM GESCHÄFT.**

### PFLEGEHINWEISE :

- 1 > SORGFÄLTIG ENTSTAUBEN.
- 2 > VERWENDEN SIE EIN TROCKENES TUCH.



**- BENUTZEN SIE KEINE  
SCHEUERMITTEL WIE PULVER,  
STAHLWOLLE, LÖSUNGSMITTEL.  
- KEIN WASSER VERWENDEN.**

	DEKORPAPIER	OBERFLÄCHE LAMINAT	OBERFLÄCHE LACK	LACKIERTEM HOLZ	TEXUL LEDER
SEIFENLAUGE (NEUTRALSEIFE)	○	○	○	○	○
WASSER MIT HAUSHALTSRFINGER		○	○		
PRODUZENT SPEZIFISCHER UNTERHALT					○

## ITALIANO - SVIZZERA

### CONSIGLI DI MONTAGGIO

- 1 > STUDIARE BENE LE ISTRUZIONI DI MONTAGGIO.
- 2 > PRENDERE CONOSCENZA DEI PEZZI CHE COSTITUISCONO IL MOBILE.
- 3 > RAGGRUPPARE E CONTROLLARE LA FERRAMENTA.
- 4 > MUNIRSI DEGLI UTENSILI NECESSARI.
- 5 > PREPARARE UNA ZONA DI MONTAGGIO.
- 6 > PROCEDERE AL MONTAGGIO.



**NON FORZARE MAI GLI ASSEMBLAGGI  
RISTRINGERE LE VITI DOPO UN PERIODO D'USO  
CONSERVARE QUESTE ISTRUZIONI DI MONTAGGIO,  
SE UN PEZZO VENISSE A MANCARE SAREBBE IL MIGLIORE  
MEZZO DI COMUNICAZIONE CON IL RIVENDITORE**

### CONSIGLI PER LA MANUTENZIONE :

- 1 > SPOLVERATE ACCURATAMENLE.
- 2 > USARE UN PANNINO ASCIUTTO.



**- NON UTILIZZARE MAI PRODOTTI  
ABRASIVI: POLVERE,  
LANA DI ACCIAIO, SOLVENTI.  
- NON BAGNARE.**

	CARTA	SUPERFICIE STRATIFICATE	SUPERFICIE LACCATE	LACCATE EGNO VERNICIATO	TESSILE CUOIO
ACQUA CON SAPONE (SAPONE NEUTRO)	○	○	○	○	○
ACQUA CON DETERSIVO SAN MARC		○	○		
MANUTENZIONE SPECIFICA PRODUTTORE					○

## PORTUGUÊS

### CONSELHOS DE MONTAGEM:

- 1 > ESTUDE BEM AS INSTRUÇÕES DE MONTAGEM.
- 2 > REUNA AS PEÇAS QUE CONSTITUEM O SEU MÓVEL.
- 3 > REAGRUPE AS FERRAGENS.
- 4 > EQUIPE-SE COM AS FERRAMENTAS NECESSÁRIAS.
- 5 > PREPARE UMA ÁREA PARA A MONTAGEM.
- 6 > INICIE A MONTAGEM.



**NUNCA FORÇAR OS ENCAIXES.  
REAPERTAR OS PARAFUSOS APÓS UM TEMPO DE UTILIZAÇÃO.  
GUARDAR AS INSTRUÇÕES DE MONTAGEM.  
CASO FALTE ALGUMA PEÇA, O MAIS ACONSELHÁVEL  
É CONTATAR O REVENDEDOR.**

### CONSELHOS PARA A MANUTENÇÃO :

- 1 > ELIMINAR BEM O PÓ.
- 2 > USAR PANO SECO.



**- NUNCA UTILIZAR PRODUTOS  
ABRASIVOS: SAPONÁCEOS,  
LÃ DE AÇO, SOLVENTES.  
- NÃO MOLHAR .**

	ACABAMENTO IMITAÇÃO	SUPERFÍCIES ESTRATIFICADAS	SUPERFÍCIES LACADAS	MADEIRA ENVERNIZADA	TEXTEIS PELES
ÁGUA COM SABÃO (SABÃO NEUTRO)	○	○	○	○	○
ÁGUA COM DETERGENTE		○	○		
INSTRUÇÕES ESPECÍFICAS DO FABRICANTE					○

## ESPAÑOL

### CONSEJOS PARA EL MONTAJE:

- 1 > ESTUDIE ATENTAMENTE EL MANUAL DE MONTAJE.
- 2 > LOCALICE LAS PIEZAS QUE CONSTITUYEN SU MUEBLE.
- 3 > REUNA Y CONTROLE LOS TORNILLOS.
- 4 > EQUIPE-SE DE LAS HERRAMIENTAS NECESARIAS.
- 5 > PREPARE UNA ZONA DE MONTAJE.
- 6 > REALICE EL MONTAJE.



**NO FUERCE NUNCA EN LAS UNIONES. APRIETE LOS  
TORNILLOS DESPUES DE CIERTO TIEMPO DE UTILIZACION  
CONSERVE SU MANUAL DE MONTAJE,  
SI FALTARA UNA PIEZA, SERIA LA MANERA  
MAS FACIL DE COMUNICAR CON LA TIENDA.**

### CONSEJOS PARA EL MANTENIMIENTO:

- 1 > DESPOLVOREAR CULDADOSAMENTE.
- 2 > UTILICE UN PAÑO SECO.



**- NO USE NUNCA PRODUCTOS  
ABRASIVOS TALES COMO:  
POLVO DE LIMPIAR,  
LANA DE ACERO, SOLVENTES.  
- NO MOJAR.**

	PAPEL DE DECORACION	SUPERFICIE ESTRATIFICADAS	SUPERFICIE MAQUEADAS	MADERA BARNIZADA	TEXULL CUERO
AGUA Y JABON (JABON NEUTRO)	○	○	○	○	○
AGUA COM DETERGENTE		○	○		
MANTENIMIENTO ESPECIFICO DEL FABRICANTE					○

## HRVATSKA

### UPUTE ZA MONTAŽU:

- 1 > PAŽLJIVO PROČITAJTE UPUTE ZA MONTAŽU.
- 2 > PRIPREMITE SVE DIJELOVE NAMJEŠTAJA.
- 3 > PRIKUPITE I PROVJERITE OKOVE ZA MONTAŽU.
- 4 > PRIPREMITE POTREBAN ALAT.
- 5 > PRIPREMITE PROSTOR ZA MONTAŽU.
- 6 > POČNITE MONTIRATI.



**NEMOJTE UPOTREBLJAVATI SILU PRILIKOM SKLAPANJA  
NAKON NEKOG VREMENA PONOVRNO PRITEGNITE VIJKE  
ČUVAJTE UPUTE ZA MONTAŽU  
U SLUČAJU NEDOSTATKA NEKOG DIJELA NAJBOLJE ĆE BITI DA  
DA KONTAKIRATE PRODAJNO MJESTO.**

### UPUTE ZA ODRŽAVANJE :

- 1 > PAŽLJIVO OBRISATI PRAŠINU.
- 2 > KORISTITE SUHU KRPU.



**- ZABRANJENA JE UPOTREBA  
KEMIKALIJA ILI BILO KAKVIH  
POMOĆNIH SREDSTAVA ZA RIBANJE  
JAKIH SREDSTAV ZA ČIŠĆENJE ILI  
ČELIČNE VUNE  
-NE MOKRA.**

	PAPIR	LAMINAT	LAK	DRVO	TEKSTIL/ KOŽA
OTPINA SAPUNA	○	○	○	○	○
OTPINA DETERDŽENTA		○	○		
NAMJENSKA SREDSTVA					○

## TÜRÇE

### MONTAJ TALIMATLARI:

- 1 > MONTAJ TANITIM YAZISINI DIKKATLİCE OKUYUNUZ .
- 2 > MOBİLİYANIZI OLUŞTURAN PARÇALARI İŞARETLEYİNİZ.
- 3 > HIRDAVATLA İLGİLİ PARÇALARI BİR ARAYA TOPLAYIP; KONTROL EDİNİZ.
- 4 > GEREKEN ARAÇ VE GERECE TEDARİK EDİNİZ.
- 5 > (KENDİNİZE) BİR MONTAJ ALANI EDİNİNİZ.
- 6 > MONTE ETMEYE BAŞLAYINIZ.



**MONTAJLARI ZORLAMAYINIZ.**  
BİRKAÇ KULLANIMDAN SONRA VIDALARI SIKIŞTIRINIZ.  
BİR PARÇANIN KAYBOLMASI DURUMUNDA MAGAZANIZLADAHA,  
KOLAY İLETİŞİME GEÇEBİLMENİZ İÇİN MONTAJ KULLANIM  
TALIMATINIZI SAKLAYINIZ.

### BAKIM TALIMATLARI:

- 1 > TOZUNU DIKKATLİCE ALINIZ.
- 2 > YUMUŞAK BİR BEZİ TEMİZ SU VE AZ MIKTARDA SABUNLA(DETERJAN) NEMLENDİRİNİZ.



**ASLA AŞINDIRICI ÜRÜNLER  
KULLANMAYINIZ : ÇELİK YÜNÜ,  
SOLVENT...  
BOL SUYLA YIKAMAYINIZ.**

	SÜS KAGIDI	KATMAN YÜZEY	LAKE YÜZEY	CILALI TAHTA	TEKSTİL DERİ
SABUNLU SU (NOTR SABUN)	○	○	○	○	○
DETERJAN KATILMIŞ SU		○	○		
ÜRETİCİYE ÖZGÜ BAKIM					○

## ENGLISH

### ASSEMBLY ADVICE :

- 1 > CAREFULLY READ THE ASSEMBLY INSTRUCTION.
- 2 > IDENTIFY THE COMPONENTS OF THE FURNITURE.
- 3 > GROUP AND CHECK THE HARDWARE.
- 4 > USE THE REQUIRED TOOLS.
- 5 > CREATE AN ASSEMBLY ZONE.
- 6 > MAKE THE ASSEMBLY.



**NEVER FORCE THE CONNECTIONS.**  
RE-TIGHTEN THE SCREWS AFTER FEW DAYS.  
PLEASE RETAIN THE AI LEAFLET FOR FUTURE REFERENCE,  
THE AI CONTAINS INFORMATION WHEN CLAIMING  
FOR MISSING PARTS.

### CLEANING ADVICE:

- 1 > CAREFULLY REMOVE THE DUST.
- 2 > USE A SOFT, CLEAN DAMP CLOTH WITH SOAPY WATER.



**NEVER USE ABRASIVE PRODUCTS  
OR SOLVENTS.  
DO NOT APPLY EXCESSIVE PRESSURE  
WHEN USING THE DAMP CLOTH.**

	PAPER DECOR	LAMINATED SURFACES	LACQUERED SURFACE	VARNISHED WOOD	LEATHER TEXTILE
SOAPY WATER (NEUTRAL SOAP)	○	○	○	○	○
WATER WITH DETERGENT		○	○		
SPECIFIC SUPPLIER CLEANING					○

**PENSEZ AU TRI !**  
ENSEMBLE RÉDUISONS  
L'IMPACT ENVIRONNEMENTAL  
DES ENBALLAGES

ÉLÉMENT(S)  
PLASTIQUE(S)



À JETER

ÉLÉMENT(S)  
MÉTAL(S)  
CARTON(S) PAPIER(S)



À RECYCLER



CONSIGNE POUVANT VARIER LOCALEMENT > [WWW.CONSIGNESDETRI.FR](http://WWW.CONSIGNESDETRI.FR)



FR

**Donnez ou recyclez  
vos meubles.**



Association

OU



Magasin

OU



Déchèterie